

Preform 28/410 - 23 g



TECNICAL SPECIFICATION

DESCRIPTION PREFORM 28/410 - 23 g

NECK TYPE 28/410

WEIGHT 23 g

NECK WEIGHT 2.51 g

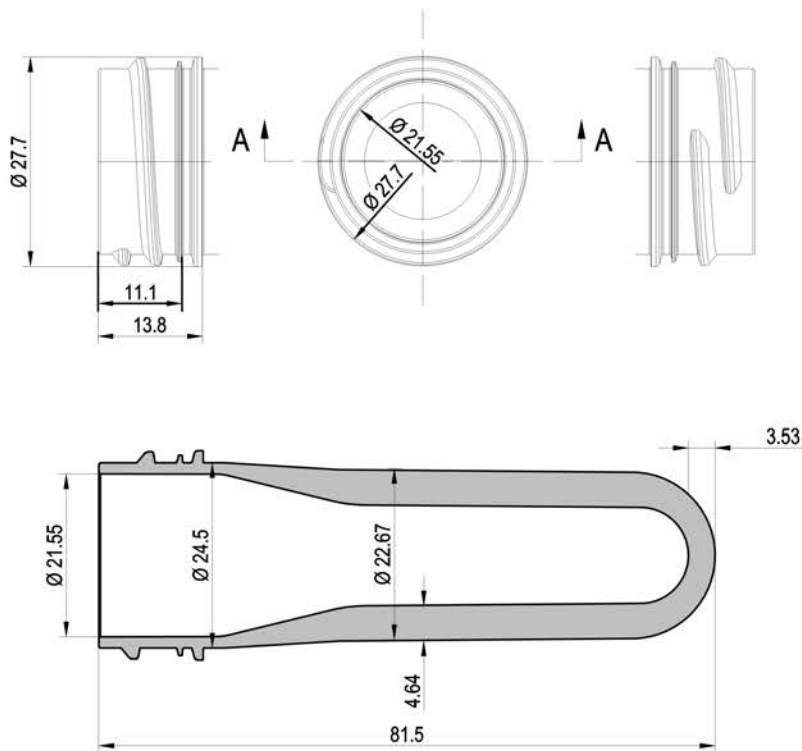

MATERIAL PET / R - PET

SPECIFIC WIEGHT 1.335 g/cm²

PACKAGING Pallet 100x120 cm - 120x120 cm
Octabin 120x120x118 cm - 100x120x118 cm
Polyethylene bag 200x250 cm - 190+20+20x250 cm

STORAGE Store the product in a dry place not exposed to sunlight
Maximum number of stackable Octabins 3
Before use, store for 24 hours in a room at a temperature between 18 ° -40 ° C
Use the product within 12 months from the date of receipt

NOTE